

Kabelstecker, weiß
Male cable connector, white

Kabelstecker, rot, blau, grün
Male cable connector, red, blue, green

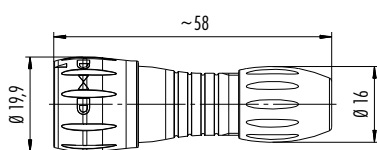

Polzahl Contacts	Kabeldurchlass Cable outlet	Bestell-Nr. Ordering-No.	Polzahl Contacts	Kabeldurchlass Cable outlet	Rot Red	Blau Blue	Grün Green
8	2,5–4 mm	99 0771 400 08	8	2,5–4 mm	99 0771 450 08	99 0771 460 08	99 0771 470 08

Polzahl	8	Number of contacts
Steckverbinder Verriegelung	Bajonett/bayonet	Connector locking system
Anschlussart	löten/solder	Termination
Anschlussquerschnitt	0,25 mm ² (AWG 24)	Wire gauge
Kabeldurchlass	2,5–4 mm, 4–6 mm, 6–8 mm	Cable outlet
Schutzart	IP67	Degree of protection
Mechanische Lebensdauer	> 5000 Steckzyklen/> 5000 mating cycles	Mechanical operation
Obere Grenztemperatur	+ 85 °C	Upper temperature
Untere Grenztemperatur	- 25 °C	Lower temperature
Bemessungsspannung	175 V	Rated voltage
Bemessungs-Stoßspannung	1750 V	Rated impulse voltage
Verschmutzungsgrad	2	Pollution degree
Überspannungskategorie	II	Overvoltage categorie
Isolierstoffgruppe	II	Material group
Bemessungsstrom (40°C)	2 A	Rated current (40 °C)
Material Kontakt	CuZn (Messing/brass)	Material of contact
Kontaktoberfläche	Au (Gold/gold)	Contact plating
Material Kontaktkörper	PA	Material of contact body
Material Gehäuse	PA	Material of housing
Material Verriegelung	PA	Material of locking

Kabelstecker, weiß
Male cable connector, white

Kabelstecker, rot, blau, grün
Male cable connector, red, blue, green

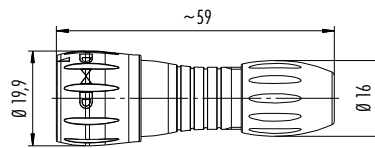

Polzahl Contacts	Kabeldurchlass Cable outlet	Bestell-Nr. Ordering-No.	Polzahl Contacts	Kabeldurchlass Cable outlet	Rot Red	Blau Blue	Grün Green
8	4–6 mm	99 0771 401 08	8	4–6 mm	99 0771 451 08	99 0771 461 08	99 0771 471 08

Polzahl	8	Number of contacts
Steckverbinder Verriegelung	Bajonett/bayonet	Connector locking system
Anschlussart	löten/solder	Termination
Anschlussquerschnitt	0,25 mm ² (AWG 24)	Wire gauge
Kabeldurchlass	2,5–4 mm, 4–6 mm, 6–8 mm	Cable outlet
Schutzart	IP67	Degree of protection
Mechanische Lebensdauer	> 5000 Steckzyklen/> 5000 mating cycles	Mechanical operation
Obere Grenztemperatur	+ 85 °C	Upper temperature
Untere Grenztemperatur	– 25 °C	Lower temperature
Bemessungsspannung	175 V	Rated voltage
Bemessungs-Stoßspannung	1750 V	Rated impulse voltage
Verschmutzungsgrad	2	Pollution degree
Überspannungskategorie	II	Overvoltage categorie
Isolierstoffgruppe	II	Material group
Bemessungsstrom (40°C)	2 A	Rated current (40 °C)
Material Kontakt	CuZn (Messing/brass)	Material of contact
Kontaktoberfläche	Au (Gold/gold)	Contact plating
Material Kontaktkörper	PA	Material of contact body
Material Gehäuse	PA	Material of housing
Material Verriegelung	PA	Material of locking

Kabelstecker, weiß
Male cable connector, white

Kabelstecker, rot, blau, grün
Male cable connector, red, blue, green

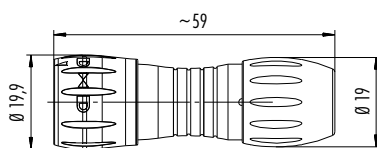

Polzahl Contacts	Kabeldurchlass Cable outlet	Bestell-Nr. Ordering-No.	Polzahl Contacts	Kabeldurchlass Cable outlet	Rot Red	Blau Blue	Grün Green
8	6–8 mm	99 0771 402 08	8	2,5–4 mm	99 0771 452 08	99 0771 462 08	99 0771 472 08

Polzahl	8	Number of contacts
Steckverbinder Verriegelung	Bajonett/bayonet	Connector locking system
Anschlussart	löten/solder	Termination
Anschlussquerschnitt	0,25 mm ² (AWG 24)	Wire gauge
Kabeldurchlass	2,5–4 mm, 4–6 mm, 6–8 mm	Cable outlet
Schutzart	IP67	Degree of protection
Mechanische Lebensdauer	> 5000 Steckzyklen/> 5000 mating cycles	Mechanical operation
Obere Grenztemperatur	+ 85 °C	Upper temperature
Untere Grenztemperatur	- 25 °C	Lower temperature
Bemessungsspannung	175 V	Rated voltage
Bemessungs-Stoßspannung	1750 V	Rated impulse voltage
Verschmutzungsgrad	2	Pollution degree
Überspannungskategorie	II	Overvoltage categorie
Isolierstoffgruppe	II	Material group
Bemessungsstrom (40°C)	2 A	Rated current (40 °C)
Material Kontakt	CuZn (Messing/brass)	Material of contact
Kontaktoberfläche	Au (Gold/gold)	Contact plating
Material Kontaktkörper	PA	Material of contact body
Material Gehäuse	PA	Material of housing
Material Verriegelung	PA	Material of locking

Flanschdose, löten, weiß
Female panel mount connector,
solder, white

Flanschdose, löten, rot
Female panel mount connector,
solder, red

Flanschdose, löten, blau
Female panel mount connector,
solder, blue

Flanschdose, löten, grün
Female panel mount connector,
solder, green

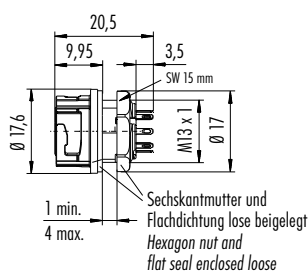

Polzahl Contacts	Bestell-Nr. Ordering-No.	Polzahl Contacts	Bestell-Nr. Ordering-No.	Polzahl Contacts	Bestell-Nr. Ordering-No.	Polzahl Contacts	Bestell-Nr. Ordering-No.
8	09 0774 400 08	8	09 0774 450 08	8	09 0774 460 08	8	09 0774 470 08

Polzahl	8	Number of contacts
Steckverbinder Verriegelung	Bajonett/bayonet	Connector locking system
Anschlussart	löten/solder	Termination
Anschlussquerschnitt	0,25 mm ² (AWG 24)	Wire gauge
Kabeldurchlass	—	Cable outlet
Schutzart	IP67 auch ungesteckt/also when not mated	Degree of protection
Mechanische Lebensdauer	> 5000 Steckzyklen/> 5000 mating cycles	Mechanical operation
Obere Grenztemperatur	+ 85 °C	Upper temperature
Untere Grenztemperatur	- 25 °C	Lower temperature
Bemessungsspannung	175 V	Rated voltage
Bemessungs-Stoßspannung	1750 V	Rated impulse voltage
Verschmutzungsgrad	2	Pollution degree
Überspannungskategorie	II	Overvoltage categorie
Isolierstoffgruppe	II	Material group
Bemessungsstrom (40°C)	2 A	Rated current (40 °C)
Material Kontakt	CuSn (Bronze/bronze)	Material of contact
Kontaktoberfläche	Au (Gold/gold)	Contact plating
Material Kontaktkörper	PA	Material of contact body
Material Gehäuse	PA	Material of housing
Material Verriegelung	—	Material of locking

Flanschdose, löten, von vorn verschraubbar, weiß
Female panel mount connector, solder, front fastened, white

Flanschdose, löten, von vorn verschraubbar, rot
Female panel mount connector, solder, front fastened, red

Flanschdose, löten, von vorn verschraubbar, blau
Female panel mount connector, solder, front fastened, blue

Flanschdose, löten, von vorn verschraubbar, grün
Female panel mount connector, solder, front fastened, green

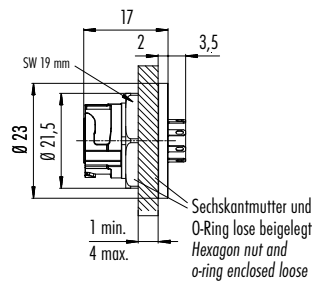

Polzahl Contacts	Bestell-Nr. Ordering-No.	Polzahl Contacts	Bestell-Nr. Ordering-No.	Polzahl Contacts	Bestell-Nr. Ordering-No.	Polzahl Contacts	Bestell-Nr. Ordering-No.
8	09 0774 580 08	8	09 0774 585 08	8	09 0774 586 08	8	09 0774 587 08

Polzahl	8	Number of contacts
Steckverbinder Verriegelung	Bajonett/bayonet	Connector locking system
Anschlussart	löten/solder	Termination
Anschlussquerschnitt	0,25 mm ² (AWG 24)	Wire gauge
Kabeldurchlass	—	Cable outlet
Schutzart	IP67 auch ungesteckt/also when not mated	Degree of protection
Mechanische Lebensdauer	> 5000 Steckzyklen/> 5000 mating cycles	Mechanical operation
Obere Grenztemperatur	+ 85 °C	Upper temperature
Untere Grenztemperatur	- 25 °C	Lower temperature
Bemessungsspannung	175 V	Rated voltage
Bemessungs-Stoßspannung	1750 V	Rated impulse voltage
Verschmutzungsgrad	2	Pollution degree
Überspannungskategorie	II	Overvoltage categorie
Isolierstoffgruppe	II	Material group
Bemessungsstrom (40°C)	2 A	Rated current (40 °C)
Material Kontakt	CuSn (Bronze/bronze)	Material of contact
Kontaktoberfläche	Au (Gold/gold)	Contact plating
Material Kontaktkörper	PA	Material of contact body
Material Gehäuse	PA	Material of housing
Material Verriegelung	—	Material of locking

Flanschdose, tauchlöten, weiß
Female panel mount connector,
dip solder, white

Flanschdose, tauchlöten, rot
Female panel mount connector,
dip solder, red

Flanschdose, tauchlöten, blau
Female panel mount connector,
dip solder, blau

Flanschdose, tauchlöten, grün
Female panel mount connector,
dip solder, green



Bohrbild siehe Seite 33
Drilling scheme see page 33

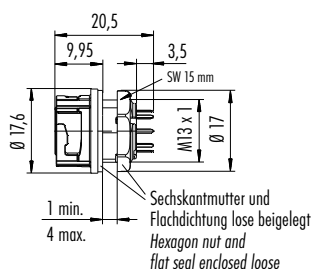

Polzahl Contacts	Bestell-Nr. Ordering-No.	Polzahl Contacts	Bestell-Nr. Ordering-No.	Polzahl Contacts	Bestell-Nr. Ordering-No.	Polzahl Contacts	Bestell-Nr. Ordering-No.
8	09 0774 490 08	8	09 0774 495 08	8	09 0774 496 08	8	09 0774 497 08

Polzahl	8	Number of contacts
Steckverbinder Verriegelung	Bajonett/bayonet	Connector locking system
Anschlussart	tauchlöten/dip solder	Termination
Anschlussquerschnitt	—	Wire gauge
Kabeldurchlass	—	Cable outlet
Schutzart	IP67 auch ungesteckt/also when not mated	Degree of protection
Mechanische Lebensdauer	> 5000 Steckzyklen/> 5000 mating cycles	Mechanical operation
Obere Grenztemperatur	+ 85 °C	Upper temperature
Untere Grenztemperatur	- 25 °C	Lower temperature
Bemessungsspannung	175 V	Rated voltage
Bemessungs-Stoßspannung	1750 V	Rated impulse voltage
Verschmutzungsgrad	2	Pollution degree
Überspannungskategorie	II	Overvoltage categorie
Isolierstoffgruppe	II	Material group
Bemessungsstrom (40°C)	2 A	Rated current (40 °C)
Material Kontakt	CuSn (Bronze/bronze)	Material of contact
Kontaktoberfläche	Au (Gold/gold)	Contact plating
Material Kontaktkörper	PA	Material of contact body
Material Gehäuse	PA	Material of housing
Material Verriegelung	—	Material of locking

Flanschdose, tauchlöten, von vorn verschraubbar, weiß
Female panel mount connector, dip solder, front fastened, white

Flanschdose, tauchlöten, von vorn verschraubbar, rot
Female panel mount connector, dip solder, front fastened, red

Flanschdose, tauchlöten, von vorn verschraubbar, blau
Female panel mount connector, dip solder, front fastened, blau

Flanschdose, tauchlöten, von vorn verschraubbar, grün
Female panel mount connector, dip solder, front fastened, green



Bohrbild siehe Seite 33
Drilling scheme see page 33

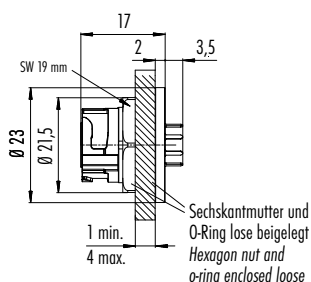

Polzahl Contacts	Bestell-Nr. Ordering-No.	Polzahl Contacts	Bestell-Nr. Ordering-No.	Polzahl Contacts	Bestell-Nr. Ordering-No.	Polzahl Contacts	Bestell-Nr. Ordering-No.
8	09 0774 590 08	8	09 0774 595 08	8	09 0774 596 08	8	09 0774 597 08

Polzahl	8	Number of contacts
Steckverbinder Verriegelung	Bajonett/bayonet	Connector locking system
Anschlussart	tauchlöten/dip solder	Termination
Anschlussquerschnitt	—	Wire gauge
Kabeldurchlass	—	Cable outlet
Schutzart	IP67 auch ungesteckt/also when not mated	Degree of protection
Mechanische Lebensdauer	> 5000 Steckzyklen/> 5000 mating cycles	Mechanical operation
Obere Grenztemperatur	+ 85 °C	Upper temperature
Untere Grenztemperatur	- 25 °C	Lower temperature
Bemessungsspannung	175 V	Rated voltage
Bemessungs-Stoßspannung	1750 V	Rated impulse voltage
Verschmutzungsgrad	2	Pollution degree
Überspannungskategorie	II	Overvoltage categorie
Isolierstoffgruppe	II	Material group
Bemessungsstrom (40°C)	2 A	Rated current (40 °C)
Material Kontakt	CuSn (Bronze/bronze)	Material of contact
Kontaktoberfläche	Au (Gold/gold)	Contact plating
Material Kontaktkörper	PA	Material of contact body
Material Gehäuse	PA	Material of housing
Material Verriegelung	—	Material of locking

Montageanleitung
Assembly instruction

1. Abmanteln auf L = 9 mm. Ummantlung abstreifen.
 2. Druckschraube, Klemmkorb, Dichtring und Abstandshülse auf Kabel aufhängen.
 3. Litzen abisolieren (L = 3 mm) und verzinnen.
 4. Einsätze einlöten.
 5. Bajonettadapter am Gewinde der Abstandshülse aufsetzen und mit leichtem Druck in Pfeilrichtung festschrauben.
 6. Den Klemmkorb über den Dichtring bis auf Anschlag aufchieben.
 7. Mit Druckschraube Klemm-, Dichteinheit gegen Abstandshülse drücken und festschrauben.
1. Strip to 9 mm length and take off the cable jacket.
 2. Bead pressing screw, pinch ring, seal and distance sleeve to cable.
 3. Strip the insulation off the wires (L = 3 mm) and tin them.
 4. Solder inserts.
 5. Put bayonet adapter to the thread of the distance sleeve and screw it with slight pressure in the direction of the arrow.
 6. Push pinch ring over sealing ring to block.
 7. Push pressing screw together with clamp-sealing unit towards distance sleeve and screw tightly.

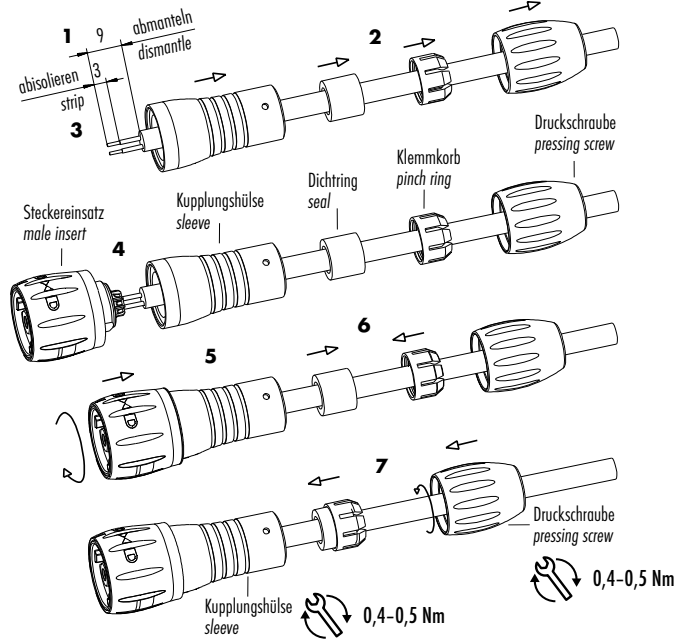

Einzelteildarstellung
Component part drawing

Flanschdose, löten
Female panel mount connector, solder

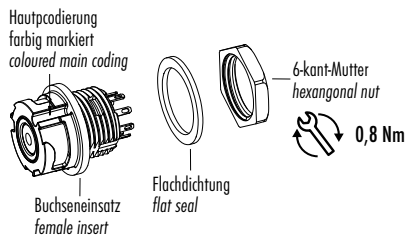

Flanschdose, tauchlöten
Female panel mount connector, dip solder

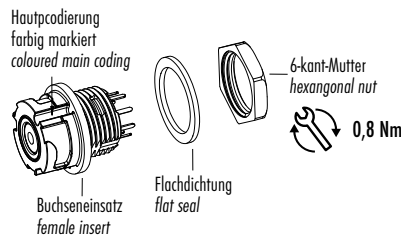

Flanschdosen, von vorn verschraubbar
Female panel mount connectors, front fastened

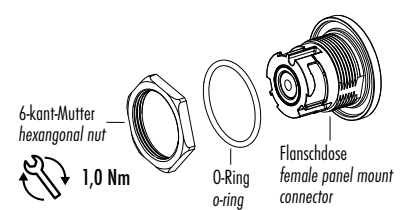

Polbilder
Contact arrangements

8 pol
8 contacts

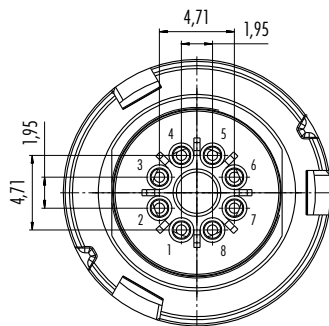

Stifteinsatz (Anschlussseite)
Male insert (termination side)

Buchseinsatz (Anschlussseite)
Female insert (termination side)

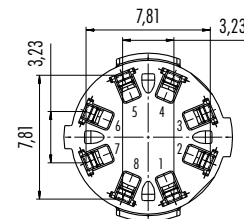

8 pol
8 contacts

Bohrbilder Stifteinsatz (Leiterplatte)
Drilling schemes male insert (PCB)



Bohrbilder Buchseinsatz (Leiterplatte)
Drilling schemes female insert (PCB)

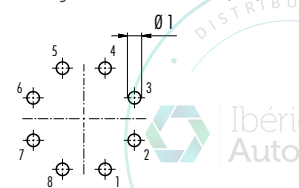

Montageausschnitt
Panel cut out

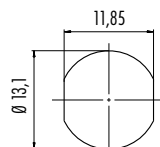

Flanschsteckverbinder
Panel mount connectors

Flanschsteckverbinder, von vorn verschraubbar
Panel mount connectors, front fastened

