

- Cierre snap-in
- 3 – 8 pines
- Tipo de protección IP67
- Unión para soldar
- Diámetro 11,5 mm



Denominación	Dibujo acotado	Número de pines	Paso de cable	Negro
Conector de cable macho		3	3–5 mm	99 9205 00 03
		4		99 9209 00 04
		5		99 9213 00 05
		8		99 9225 00 08



Denominación	Dibujo acotado	Número de pines	Paso de cable	Negro		
				Rojo	Azul	Verde
Conector de cable macho, rojo, azul, verde		3	3–5 mm	99 9205 050 03	99 9205 060 03	99 9205 070 03
		4		99 9209 050 04	99 9209 060 04	99 9209 070 04
		5		99 9213 050 05	99 9213 060 05	99 9213 070 05
		8		99 9225 050 08	99 9225 060 08	99 9225 070 08



Denominación	Dibujo acotado	Número de pines	Paso de cable	Negro		
				Rojo	Azul	Verde
Conector de cable hembra		3	3–5 mm	99 9206 00 03		
		4		99 9210 00 04		
		5		99 9214 00 05		
		8		99 9226 00 08		



Denominación	Dibujo acotado	Número de pines	Paso de cable	Negro		
				Rojo	Azul	Verde
Conector de cable hembra, rojo, azul, verde		3	3–5 mm	99 9206 050 03	99 9206 060 03	99 9206 070 03
		4		99 9210 050 04	99 9210 060 04	99 9210 070 04
		5		99 9214 050 05	99 9214 060 05	99 9214 070 05
		8		99 9226 050 08	99 9226 060 08	99 9226 070 08



Datos técnicos

Número de pines	3	4	5	8
Sección de conexión	máx. 0,25 mm ² (máx. AWG 24)			
Vida útil mecánica	> 500 Ciclos de conexión			
Temperatura límite	– 25 °C / + 85 °C			
Tensión nominal	125 V			63 V
Grado de suciedad	2			
Corriente nominal (40°C)	3 A	2,5 A	2 A	
Superficie de contacto	Au (oro)			
Material de la carcasa	PA			



Denominación

Dibujo acotado

Número de pines

Longitud del cable, PUR

Referencia

Conector de cable macho, revestido

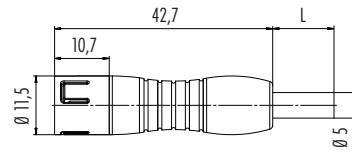

3 x 0,25	2 m	79 9237 020 03
4 x 0,25		79 9241 020 04
5 x 0,25		79 9245 020 05
8 x 0,25		79 9257 020 08

Conector de cable hembra, revestido

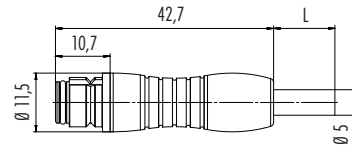

3 x 0,25	2 m	79 9238 020 03
4 x 0,25		79 9242 020 04
5 x 0,25		79 9246 020 05
8 x 0,25		79 9258 020 08

Conector de brida macho, unión para soldar

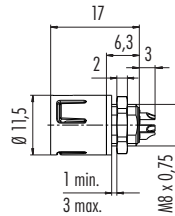

Negro

3	99 9207 00 03
4	99 9211 00 04
5	99 9215 00 05
8	99 9227 00 08

Conector de brida macho, unión para soldar



Rojo

Azul

Verde

3	99 9207 050 03	99 9207 060 03	99 9207 070 03
4	99 9211 050 04	99 9211 060 04	99 9211 070 04
5	99 9215 050 05	99 9215 060 05	99 9215 070 05
8	99 9227 050 08	99 9227 060 08	99 9227 070 08

Conector de brida macho, unión para soldar por inmersión

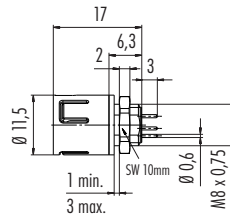

Negro

3	99 9207 090 03
4	99 9211 090 04
5	99 9215 090 05
8	99 9227 090 08

Conector de brida hembra, unión para soldar

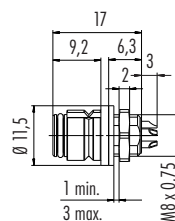

3	99 9208 00 03
4	99 9212 00 04
5	99 9216 00 05
8	99 9228 00 08



Denominación	Dibujo acotado	Número de pines	Rojo	Azul	Verde
Conector de brida hembra, unión para soldar		3	99 9208 050 03	99 9208 060 03	99 9208 070 03
		4	99 9212 050 04	99 9212 060 04	99 9212 070 04
		5	99 9216 050 05	99 9216 060 05	99 9216 070 05
		8	99 9228 050 08	99 9228 060 08	99 9228 070 08



Negro

Conector de brida hembra, unión para soldar por inmersión	3	99 9208 090 03
	4	99 9212 090 04
	5	99 9216 090 05
	8	99 9228 090 08

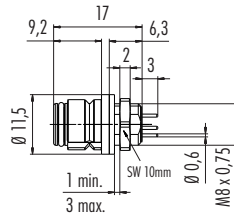

Referencia

Adaptador para conjunto conector con brida	08 2636 000 001
--	-----------------

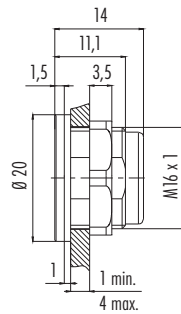

Adaptador para conjunto conector con brida, atornillable por delante	08 2629 000 001
--	-----------------

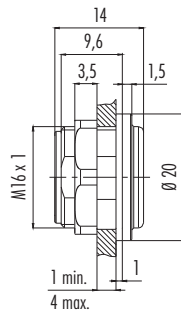

Despiece

Conjunto conector

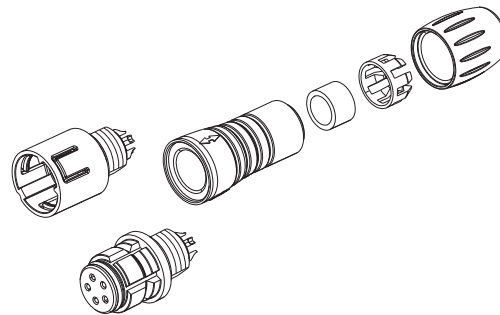

- Inserto macho
- Inserto hembra
- Manguito de acoplamiento
- Junta anular
- Tuerca de apriete
- Tornillo de presión

Conjunto conector con brida

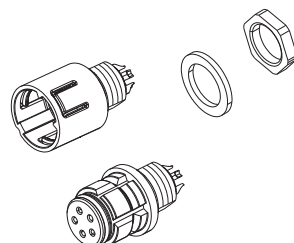

Despiece

Adaptador

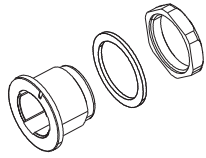

Adaptador
Junta plana
Tuerca hexagonal

Adaptadores, atornillable por delante

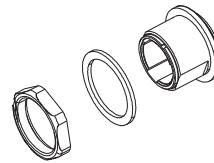

Tuerca hexagonal
Junta plana
Adaptador

Diagramas de pines, inserto macho (lado de inserción)

3 pines



4 pines



5 pines



8 pines



Diagramas de pines, inserto hembra (lado de inserción)



Escotadura para montaje

Conjunto conector con brida

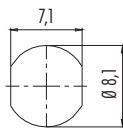

Adaptador

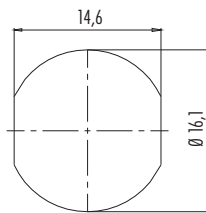

Color del cordón, conjunto conector revestido

- 1 blanco
- 2 marrón
- 3 verde
- 4 amarillo
- 5 gris
- 6 rosa
- 7 azul
- 8 rojo

Denominación

Dibujo acotado

Referencia

Tapón para conector de cable macho

08 2813 000 000

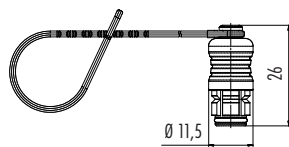

Tapón para conector de cable hembra

08 2823 000 000

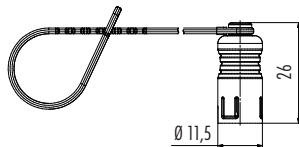

Tapón para conector de brida macho

08 2839 000 000

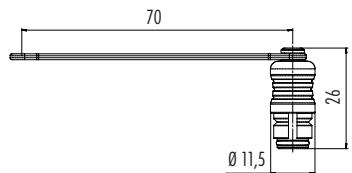

Tapón para conector de brida hembra

08 2831 000 000

