

Selection diagram

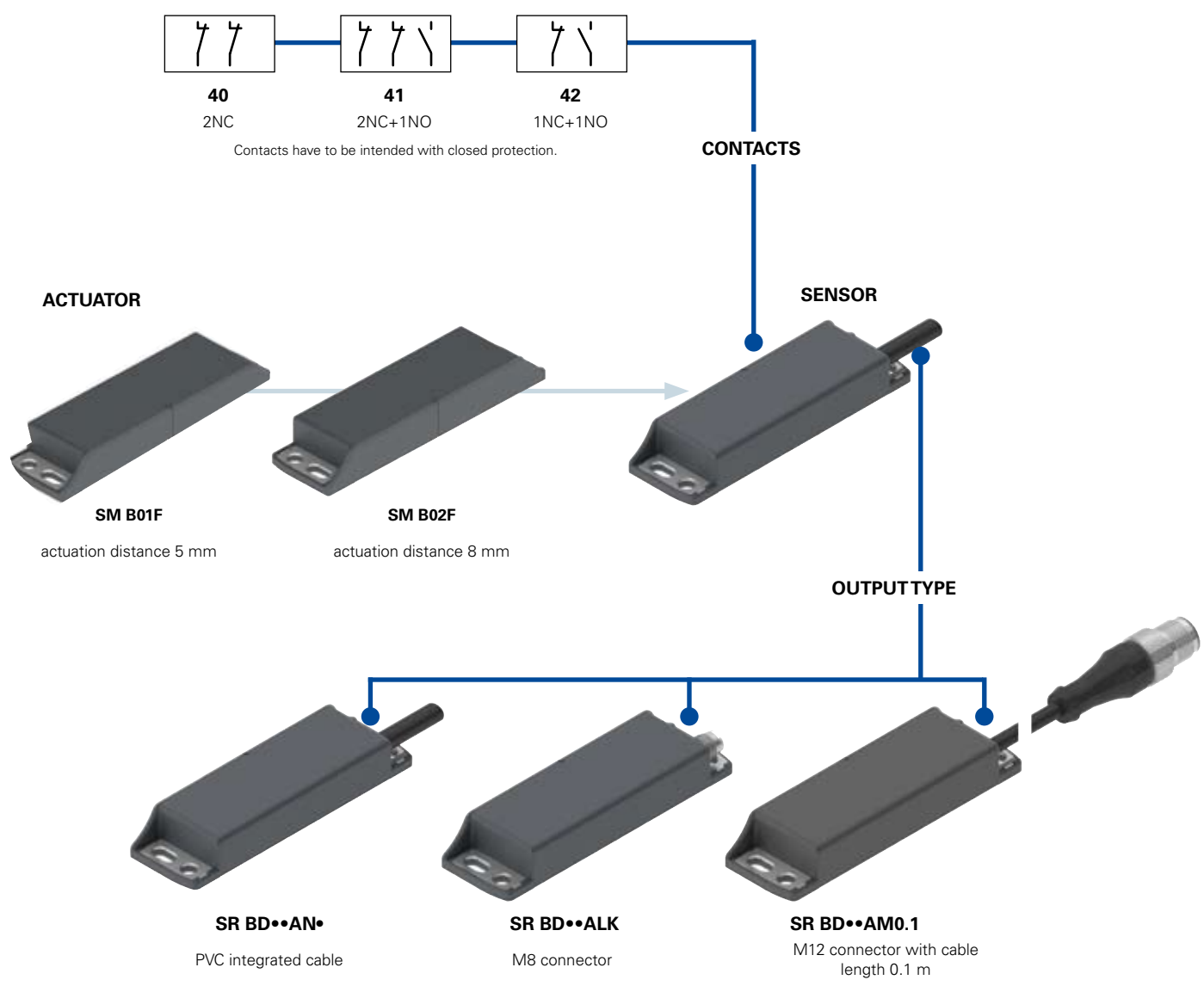

● product option
 → accessory sold separately

**Introduction**

Coded magnetic sensors are devices studied to monitor protections and guards that, when linked to a safety module, can create a system with safety category up to SIL 3 according to EN 62061, up to PLe according to EN ISO 13849-1 and up to category 4 according to EN ISO 13849-1. These products are composed by a magnetic field monitoring sensor, which is connected to the machine structure; and by a coded magnetic actuator, which has to be connected to the mobile guards. When sensor and actuator are neared (closed guard), the sensor recognizes the actuator and provides to actuate electric contacts. The sensor is manufactured to be activated only by the correct coded actuator and not through a common magnet.

Sensor with actuator code structure**SR BD40AN2-B01F**

Sensor housing	SR polymer housing	Actuator	B01F complete with SM B01F actuator, actuation distance 5 mm
			B02F complete with SM B02F actuator, actuation distance 8 mm
Contacts (with closed protection)	40 2NC (standard)	Type of cable or connector	N1 integrated PVC cable, length 1 m
	41 1NO+2NC (standard)		N2 integrated PVC cable, length 2 m (standard)
	42 1NO+1NC		...
			N10 Integrated PVC cable, length 10 m
			M0.1 M12 connector with cable length 0.1 m
			LK M8 connector (available with 40 and 42 contacts only)

Single sensor code structure**SR BD40AN2**

Sensor housing	SR polymer housing	Type of cable or connector	N1 integrated PVC cable, length 1 m
			N2 integrated PVC cable, length 2 m (standard)
			...
Contacts (with closed protection)	40 2NC (standard)		N10 Integrated PVC cable, length 10 m
	41 1NO+2NC (standard)		M0.1 M12 connector with cable length 0.1 m
	42 1NO+1NC		LK M8 connector (available with 40 and 42 contacts only)

Single actuator code structure**SM B01F**

Actuator	B01F actuation distance 5 mm
	B02F actuation distance 8 mm

**Main data**

- Long life, no mechanical wear
- Stainless steel fixing plates
- Output contacts: 2NC, 1NO+2NC or 1NO+1NC
- Insensitive to dirt
- Protection degree IP67 and IP69K
- Coded actuator
- Polymer housing
- Versions with M8 or M12 connector

Markings and quality marks:

Approval UL: E131787
 Approval TÜV SÜD: Z10 10 09 75157 001
 Approval GOST: POCC IT.AB24.B04512

In conformity with requirements requested by:

Low Voltage Directive 2006/95/EC
 Machinery Directive 2006/42/EC
 Electromagnetic Compatibility 2004/108/EC.

Technical data**Housing**

Made of glass-reinforced polymer, self-extinguishing, shock-proof thermoplastic resin. Version with integrated cable with 4 or 6 x 0.25 mm² wires length 2 m, other lengths on request.

Versions with M8 connector

Versions with M12 connector with cable length 0.1 m

Protection degree:

IP67 according to EN 60529
 IP69K according to DIN 40050

(Protect the cables from direct high-pressure and high-temperature jets)

General data

For safety applications up to SIL 3 / PL e

Safety parameters:

see page 7/34

Ambient temperature:

-20°C ... +80°C

Vibrations holding:

10 gn (10...500 Hz) according to IEC 60068-2-6

Shock holding:

30 gn (11 ms) according to IEC 60068-2-27

Pollution degree

3

Max screw driving torque:

0,8 ... 2 Nm

In conformity with standards:

IEC 60947-1, EN 60947-1, IEC 60947-5-1, EN 60947-5-1, EN 60947-5-2, EN 60947-5-3 (in connection with safety module), EN 1088, EN ISO 14119, EN ISO 12100-1, EN ISO 12100-2, EN ISO 13849-1, EN ISO 13849-2, IEC 60204-1, EN 60204-1, IEC 60529, EN 60529, DIN 40050.

Approvals:

UL 508.

Actuating data

Assured operating distance Sao

5 mm with actuator SM B01F

Assured release distance Sar

15 mm with actuator SM B01F

Assured operating distance Sao

8 mm with actuator SM B02F

Assured release distance Sar

20 mm with actuator SM B02F

Repeat accuracy

≤ 10%

Frequency of operating cycles

up to 150 Hz

Distance between two sensors

Min. 50 mm

Electrical data

Rated insulation voltage Ui:

120 Vac (with cable)
 60 Vac / 75 Vdc (with M8 connector)
 120 Vac (with 4 poles M12 connector)
 30 Vac / 36 Vdc (with 8 poles M12 connector)

Rated impulse withstand voltage (U_{imp}):

6 kV
 1,5 kV (with connector)

Thermal current I_{th}:

0.25 A

Max switching load:

6 W (resistive load)

Rated operational voltage (U_e):

24 Vac/dc

Rated operational current (I_e):

0.25 A (resistive load)

Protection fuse:

0.25 A type F

Electrical endurance:

1 million operations cycles

Connection with safety modules with personnel protection function:

Connection with safety modules CS AR-01•E02; CS AR-02•E02; CS AR-04•024; CS AR-05•••••; CS AR-06•••••; CS AR-08•••••; CS AR-46•024; CS AR-94•••••; CS AR-95•••••; CS AT-0•••••; CS AT-1•••••; CS AT-3•••••; CS FS-5•••••; CS MF•••••••••; CS MP•••••••••.

The sensor connected with the safety module can be classified as device for control circuit up to PDF-M (EN 60947-5-3).

The system can be used in safety circuits up to PL_e / SIL 3 / category 4 according to EN ISO 13849-1.

Data type approved by UL

Utilization categories: 24 Vdc, 0,25 A (resistive load)

Data of the housing type 1, 4X "indoor use only", 12

Accessory for series CS.

In conformity with standard: UL 508

Please contact our technical service for the list of approved products.

Data type approved by TÜV SÜD

Supply voltage: 24 V ac/dc

Output switching current (max): 0,25 A

Working temperature: -25 °C ... + 80 °C

IP code: IP67

PL, Category: PL e, Cat. 4 with CS AR-08

Tested according to: 2006/42/EEC Machine Directive, EN ISO 13849-1:2008, EN 60947-5-3/A1:2005, EN 50178:1997, EN 61508-1:1998 (SIL 1-3), EN 61508-2:2000 (SIL 1-3), EN 61508-4:1998 (SIL 1-3), IEC 62061:2005 (SIL CL 3), EN 60947-1

Please contact our technical service for the list of approved products.



Insensitivity to dirt

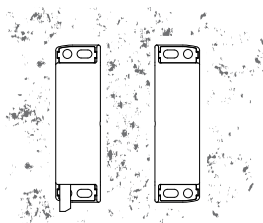

Magnetic sensors are totally sealed and maintain unchanged their safety characteristics also where dirt and dust are present (not ferromagnetic material).

This characteristic, joined with the shape without recesses, make them especially proper to be used in the food-industrial sector.

Stainless steel fixing plates

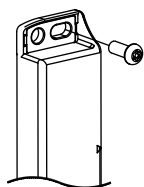

In order to avoid that the fixing on non-perfectly plane surfaces could damage the fixing slots, Pizzato Elettrica magnetic sensors are provided with stainless steel fixing plates.

Also in presence of right fixing surfaces, this solution makes the sensor stronger to mechanical stresses and so the whole system becomes safer and more reliable. Convex Torx-head security screws are available for fixing the SR sensors.

Safety screws for actuators

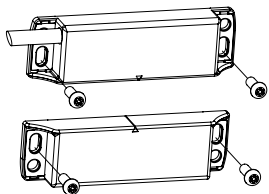

These new screws have tamper-resistant Torx buttonheads.

Devices fixed with this kind of screws cannot be removed or tampered by common tools.

See accessories page 6/5.

Laser marking



Pizzato Elettrica has introduced a new laser marking for magnetic sensors SR series. Thanks to this new system which excludes the use of labels, markings on the products are indelible.

Furthermore, in case of machineries subjected to intense high pressure water jets, there is no risk of labels detaching from the product.

Complete safety system

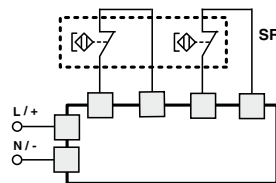

These magnetic sensors have been checked and tested for working with proper Pizzato Elettrica safety modules. Using completed and tested solutions, the customer has the certainty to have no

electric incompatibility between sensor and safety module, and has a higher reliability guarantee.

Sensors	Compatible safety modules	Safety module output contacts	
		Instantaneous	Delayed
SR BD40A** SR BD41A** SR BD42A**	CS AR-01•E02	2NO+1NC	/
	CS AR-02•E02	3NO	/
	CS AR-04•024	3NO+1NC	/
	CS AR-05•••••	3NO+1NC	/
	CS AR-06•••••	3NO+1NC	/
	CS AR-08•••••	2NO	/
	CS AR-46•024	1NO	/
	CS AR-94•••••	2NO	/
	CS AR-95•••••	2NO	/
	CS AT-0•••••	2NO+1NO	2NO
	CS AT-1•••••	3NO	2NO
	CS AT-3•••••	2NO	1NO
	CS FS-5•••••	1NO+1NC+1CO	/
	CS MP•••••••	see page 5/63	see page 5/63
	CS MF•••••••	see page 5/69	see page 5/69

* Compatible with CS MF•••••••-P4 (page 5/74) and CS MP••••••• only.
For safety modules technical data see page 5/1.

Wide actuation zone

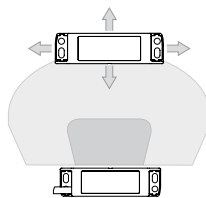

Because of their intrinsic characteristics, magnetic sensors have a wide actuation zone, which make them appreciated in the use of inaccurate protections or for protection that can change their mechanic characteristics through the time.

In this type of sensors actuation distances may change according to the actuator displacement direction from the sensor.

Actuation from many directions

Pizzato Elettrica magnetic sensors have been designed in order to be activated by the related actuator from many directions. In this way, the customer has the max flexibility about the placing of the devices along the protections perimeters.

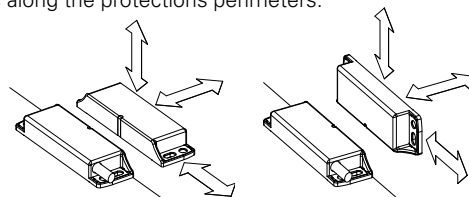

Protection degree IP67 and IP69K

IP69K
IP67

The SR series sensor by Pizzato Elettrica, besides having an IP67 protection degree, have passed the test proving their IP69K protection degree according to the prescriptions established by the DIN 40050 standard. Therefore they are suitable for use in machineries

subjected to intense washing with high pressure and high temperature water jets and for any condition or environment where a particular attention for cleanness and hygiene is required, such as in food or pharmaceutical industry.

Coded magnetic sensors used for safety applications

A coded magnetic sensor alone can not be used for safety functions because its working principles are not considered safe by the standards (as are, for example, the positive opening on mechanical switches). For this reason a coded magnetic sensor, in order to be used in safety applications, has to be compulsory connected to a proper safety module which controls correct operation, through a circuit with at least two channels.

Connection of sensors and switches in series

Pizzato Elettrica magnetic sensors could be connected in series with the only limitation that the overall resistance, gave by sensors and the related wiring, has to be not higher than the admitted max value of the module, which typically is equal to 50 ohm (see module features). It is a very high value that, with normal wiring, it allows the use of dozens of sensors without problems. It is also possible to realize mixed circuit solutions connecting in series magnetic sensor to safety switches, with the only limitation of the above mentioned max electric resistance.

We remind you that connection in series of two or more coded sensors reduce the system self-monitoring capacity which passes to category 3 in conformity with EN ISO 13849-1.

It is advisable to use safety modules by Pizzato Elettrica.

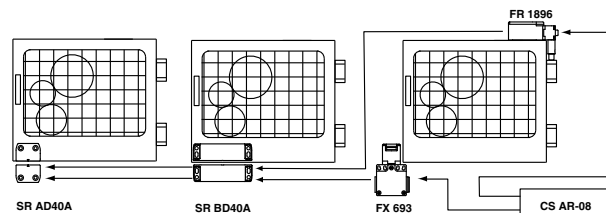

Wiring with safety modules

Wiring with safety modules CS AR-05 or CS AR-06

Input configuration with manual start (CS AR-05) and monitored start (CS AR-06)
2 channels

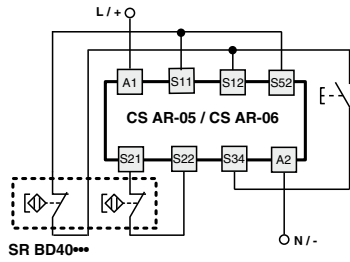

For safety modules technical data see page 5/1.

Wiring with safety module CS AR-08 or CS AT

Input configuration with manual start
2 channels

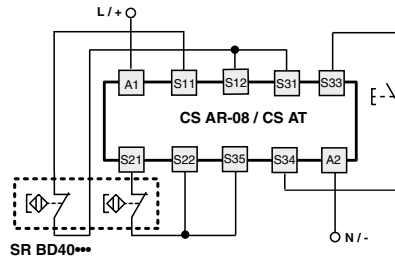

Internal connections

Contacts imply closed protection

With cable (2NC)

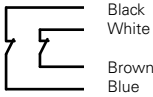

With cable (1NC+1NO)

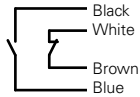

With cable (2NC+1NO)

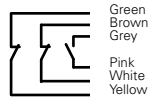

With M8 connector (2NC)

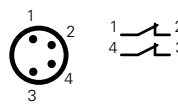

With M8 connector (1NC+1NO)

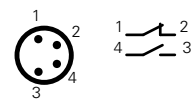

With M12 connector (2NC+1NO)

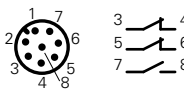

With M12 connector (2NC)

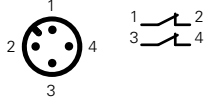

With M12 connector (1NC+1NO)

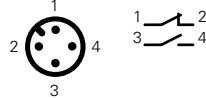

Intervention distance SR BD.....-B01F

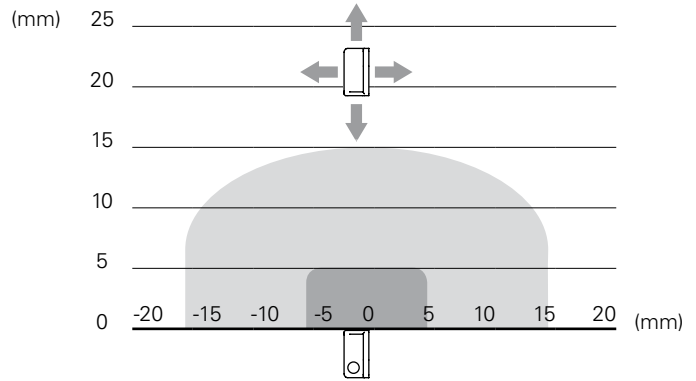
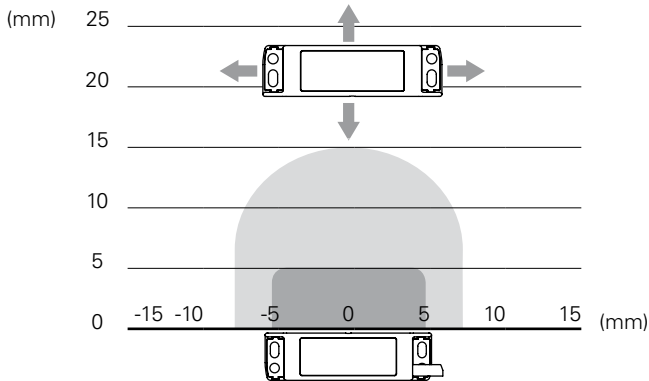

Intervention distance SR BD.....-B02F

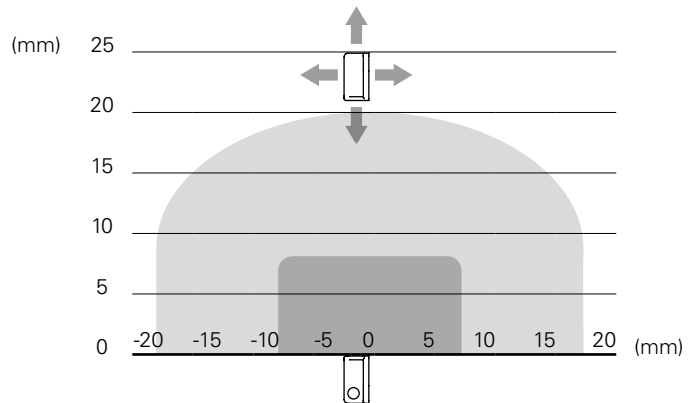
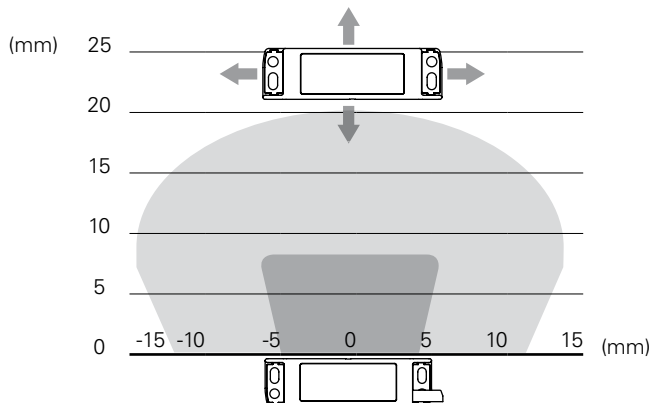

Legend:
 ■ Assured operating distance Sao
 ■ Assured release distance Sar

Note: The drawing of the activation areas is indicative.

Female connectors See page 6/2 - 6/3

**Dimensional drawings**

cable, length 2 m		M8 connector	M12 connector with cable length 0.1 m	coded actuator
SR BD40AN2	2NC	SR BD40ALK	2NC	SM B01F Actuation distance 5 mm
SR BD41AN2	1NO+2NC		SR BD41AM0.1	1NO+2NC
SR BD42AN2	1NO+1NC	SR BD42ALK	1NO+1NC	SM B02F Actuation distance 8 mm

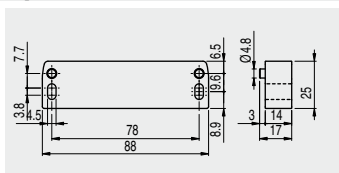
Spacer

This spacer is placed between the SR magnetic sensors and metal surfaces that can deviate the magnetic field created by the sensor: with this specific spacer between them the sensor activation

and deactivation distances remain the same.

Article	Description
VS SP1BA1	Spacers for SR B series

Utilization limits

- The installation must be performed by qualified staff only.
- Before installation and at regular interval, check the right contacts switching and the system operation of the sensor and the associated safety module.
- Do not use a hammer for adjustment.
- Do not use the sensor as a mechanical stop.
- Observe the assured operating and release distances.
- It is advisable to make adjustment observing the diagram reported in the switching distances section.
- Do not install the sensor and the actuator on strong magnetic field.
- Keep away from iron filing.

Shock, vibrations and wear:

- Do avoid impact with the sensor. Excessive shock and vibrations could not guarantee the right working of the sensor.
- The actuator must not strike sensor.
- In case of damages or wear is necessary to change the whole device, included the actuator.

Warning during the wiring:

- Keep load under the value indicated in the electrical data.
- When the sensor contacts are used without the respective safety module, connect in series to each contact the protection fuse indicated in the electrical data.
- Turn off the power supply before check the switch connection contacts, also during the wiring.

Installation on ferromagnetic material

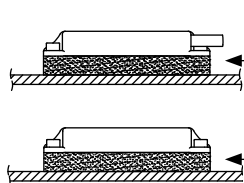

- If possible do not mount the sensor and the actuator on ferromagnetic materials.
- In order to avoid switching distances reductions, use VS SP1BA1 spacers.

Spacer

Multiple systems sensor-actuator assembly

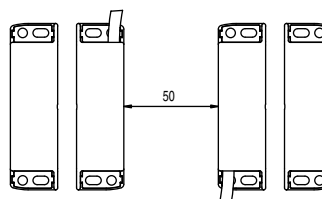

The minimum mounting gap between sensor-actuator systems must be at least 50 mm.